



CLASSIFICATION REPORT No. 14 - A - 177 - Version 5

In accordance with standards EN 12101-8: 2011 and EN 13501-4

Laboratory assessment reference

14 - A - 177 - Version 7

Concerning

A range of hinged door type smoke control dampers, AVANTAGE or AVANTAGE H type with grille, installed on a vertical smoke extraction duct:

- Commercial reference of duct:
PROMATECT L 500 th = 30 / 40 / 50 mm
GEOFLAM th = 30 / 35/ 45 mm
GEOFLAM LIGHT th = 35 mm
TECNIVER th = 35 / 45 / 50 mm
GLASROC F/V500 th = 35 / 50 mm
EXTHAMAT P th = 25 / 30 / 35 / 45 mm
DESENFIRE 25HD/25THD/35HD/25STR
GEOTEC® S th = 30 / 45 mm
Prefabricated concrete th = 70 mm
- Commercial reference of damper:
AVANTAGE 1V (ME) / 2V 60/120 / DP 60/120
AVANTAGE H 1V60 / 2V60

Applicant

RF TECHNOLOGIES
Lange Ambachtstraat 40
B – 9860 OOSTERZELE

This report annuls and replaces classification report No. 14 - A - 177 - Version 4.

DISCLAIMER : The current document is a translation of the corresponding and official French version. In all situations where the meaning of the current document is unclear or ambiguous, the French document should be used for purposes of disambiguation.

LIST OF REVISIONS

Revision index	Date	Modification	Made by
1	04/07/2016	Replacement of illustration no. 1 by three other illustrations	MFE
2	23/11/2016	<ul style="list-style-type: none"> - Installation of dampers in prefabricated concrete ducts th = 75 mm - Implementation of the decorative plaster panel of a corridor or a wall in front of the sleeve of the dampers - Installation of dampers in a duct whose widths are adapted to the dimensions of the damper - Assembly of dampers in ducts type GEOTEC® S (GEOSTAFF) of thickness 30 mm and 45 mm - Installation of dampers in ducts type EXTHAMAT P (EXTHA) of thickness 35 mm 	CSC
3	14/03/2018	Modifications to direct scope of application	MFE
4	14/02/2019	<ul style="list-style-type: none"> - Installation of dampers in ducts of EI90 performance - Change to cold seal - Modification of sub-frame 	MFE
5	16/01/2020	<p>Cold seal adding : VAME-D217</p> <p>Installation of dampers on ducts of DESENFIRE 25 STR (MF INDUSTRIES), th = 25 mm.</p>	RST

1. INTRODUCTION

The classification report defines the classification assigned to the AVANTAGE type smoke damper in accordance with the operating procedures given in standard EN 13501-4: 2016 "Fire classification of construction products and building elements - Part 4: Classifications from the fire resistance test data on the products used in the smoke extraction systems: ducts and smoke control dampers and in standard EN 12101-8 "Smoke control dampers".

2. ORGANISATION

Efectis France
Voie Romaine
F – 57280 MAIZIERES-LES-METZ

Notified body : 1812

3. APPLICANT

RF TECHNOLOGIES
Lange Ambachtstraat 40
B – 9860 OOSTERZELE

4. RÉFÉRENCE DOCUMENTS

15364A	(WFRG)
15392A	(WFRG)
15463A	(WFRG)
15511A	(WFRG)
12 - E - 440	(EFFECTIS France)
12 - E - 468	(EFFECTIS France)
13 - H - 023	(EFFECTIS France)
11 - E - 554	(EFFECTIS France)
11 - E - 655	(EFFECTIS France)
12 - U - 321	(EFFECTIS France)
EFR-15-T-001066	(EFFECTIS France)
EFR-15-T-003475	(EFFECTIS France)
EFR-15-G-003599	(EFFECTIS France)
EFR-16-G-000333b	(EFFECTIS France)
EFR-18-T-000270	(EFFECTIS France)
EFR-18-T-000496	(EFFECTIS France)

5. REFERENCE AND ORIGIN OF THE ELEMENTS EXAMINED

Reference: AVANTAGE 1V (ME) 60/120 / 2V 60/120 / DP 60/120 ou AVANTAGE H 1V60 / 2V60

Source: RF TECHNOLOGIES
Lange Ambachtstraat 40
B – 9860 OOSTERZELE

6. PRINCIPLE OF ASSEMBLY

6.1. TYPE OF FUNCTION

AVANTAGE 1V, 2V or DP and AVANTAGE H type dampers are defined as "smoke control dampers".

Their function is to resist fire, as specified by the fire resistance performance characteristics given in section 5 of standard EN 13501-4.

6.2. GENERAL

The elements tested are a range of smoke control dampers fitted in a vertical smoke extraction duct.

The AVANTAGE H range is identical in all respects to the AVANTAGE 1V/2V range. It is intended for residential housing blocks.

The smoke control dampers, with one or two pivoting doors, are constructed as follows:

- a tunnel with frame,
- one or two doors,
- a control mechanism,
- a grille.

Each damper has flush-mount measurements of between:

- for AVANTAGE 1V and AVANTAGE H1V: 300 x 385 to 700 x 1075 mm (l x h) for dampers with one door,
 - for AVANTAGE 2V and AVANTAGE H2V: 350 x 385 to 1100 x 1105 mm (l x h) for dampers with two doors,
 - for AVANTAGE 1V ME and AVANTAGE DP: 350 x 385 to 700 x 1075 mm (l x h) for dampers with one motorised door,
- Free passage: for AVANTAGE 1V and AVANTAGE H1V: (W -26) x (H-26) mm,
for AVANTAGE 2V and AVANTAGE H2V: ((W - 26) x (H - 26)),
for AVANTAGE 1V (ME) and AVANTAGE DP: (W -26) x (H -26) mm.

The smoke control duct is as described in the procès-verbal:

- no. 08-A-380 and comprises panels 30, 40 or 50 mm thick for panels in PROMATECT L500,
- no. 10-A-067 - Version 2 and comprises panels 30, 35 or 45 mm thick for panels in GEOFLAM F,
- no. 13-A-895 and comprises 35 mm thick panels for panels in GEOFLAM LIGHT,
- no. 08-A-462 - Version 2, 08-A-115 Version 1 and 13-A-1041 and comprises panels 35, 45 or 50 mm for panels in TECNIVER,
- no. PV 2013 CERIB 1296 for a vertical multi-compartment smoke extraction duct prefabricated in reinforced concrete of minimum thickness 70 mm,
- no. EFR-16-001013 - Version 1 and comprises 30 mm thick panels for panels in GEOTEC® S,
- no. EFR-16-001960 and comprises 30 mm thick panels for panels in GEOTEC® S,
- no. EFR-16-002203 and comprises 45 mm thick panels for panels in GEOTEC® S,
- no. EFR-16-002205 and comprises 45 mm thick panels for panels in GEOTEC® S.
- no. EFR 15-001253 - Version 1 and comprises 25 mm thick panels for panels in DESENFIRE HD 25
- no. EFR-15-001255 - Version 1 and comprises 25 mm thick panels for panels in DESENFIRE THD 25
- no. EFR-15-000723 - Version 1 and comprises 35 mm thick panels for panels in DESENFIRE THD 35
- no. EFR-16-003582 and comprises 25 mm thick panels for panels in DESENFIRE STR 25
- no. EFR-15-000198 and comprises 35 mm thick panels for panels in GLASROC F V500/35
- no. EFR-15-000201 and comprises 50 mm thick panels for panels in GLASROC F V500/50
- no. EFR-16-001070 and comprises 25 mm thick panels for panels in EXTHAMAT
- no. 13-A-032 and comprises 30 mm thick panels for panels in EXTHAMAT
- no. 13-A-049 and comprises 35 mm thick panels for panels in EXTHAMAT

6.3. DETAILED DESCRIPTION OF THE ELEMENTS

6.3.1. Smoke control dampers of type AVANTAGE 1V (ME) AVANTAGE DP and AVANTAGE H 1V

6.3.1.1. Door

The door is made of a Promatect H panel 15 mm thick or IGNIBOARD (manufacturer Keen Eagle) 15 mm thick of bulk density 900 kg/m³ and support profiles (two vertical and one horizontal) in galvanised steel 1.25 mm thick.

The three sections are positioned on the rear of this panel:

- the vertical support profiles are U-shaped, with dimensions 47.5 x 29.3 mm,
- the horizontal profile is C-shaped, with dimensions 69.5 x 47.5 mm.

These three profiles are fixed to the Promatect H panel with four steel rivets Ø 4.8 mm.

6.3.1.2. Damper tunnel

The tunnel is formed of a framework in extruded aluminium profiles 60 x 54 mm, assembled using Zamak connectors.

Inside, each profile is fitted along its length with a refractory panel in Promatect H of section 10 x 81 mm (th x w) fixed with steel rivets Ø 4.8 mm at 420 mm intervals.

For the Avantage 1V ME there is at mid-height a 60 x 19.5 mm steel profile 3 mm thick which is fitted into the aluminium profiles using steel rivets Ø 4.8mm.

6.3.1.3. Sealing

Cold sealing is provided by:

- a profiled rubber seal 7.3 x 23 mm for all dampers or profiled rubber seal VA-D217-B 17.6 x 7.3 mm (w x th) (except AVANTAGE DP) crimped into the extruded tunnel profile.
Or
- a profiled silicone seal 14.7 x 14.4 mm reference VAME-D217 crimped into the extruded tunnel profile.

Hot sealing is provided by an RFT EX-539P type intumescent seal or "Rectorseal Blaseseal" type seal (manufactured by Rectorseal) 15 x 2 mm, retained in the Promatect door panel using steel staples 8 x 12 mm (w x h) at 30 mm intervals.

6.3.1.4. Hinging

The door hinges on two 1.25 mm thick sheet steel hinges, having a Ø 5 mm rotating shaft, that are fixed to the door by two M5 steel bolts and nuts, and to the tunnel with three steel rivets Ø 4.8 mm. The two hinges are fitted with compression springs allowing the door to open.

6.3.1.5. Mechanism

The doors are held in the closed position by an RF-T VAL type lock, or VAL-ME for the Avantage ME, consisting of three parts in Zamak, three springs, two parts in galvanised steel, a lock and a counter-panel. The lock is fitted into the horizontal support profile using Ø 5 mm steel screws.

Manual operation is by means of a steel key.

Electrical operation is achieved by demagnetisation of the lock.

The door of the non-motorised Avantage is retained in an open position by an arm in 2 m thick folded sheet steel rotating around a \varnothing 5 mm shaft fixed to the vertical aluminium profile on the hinge side. The arm is guided in a plastic part fixed in the horizontal support section. In the open position a door spring fitted in the arm pushes the arm into an opening in the support profile.

The position of the door is detected with two position sensors, of Crouzet V4 or Keen Eagle type, installed in a plastic part held in the horizontal support profile. The position sensors and lock are connected with an "Atem euro connector block" terminal block, fitted in a connecting unit that is snapped into the aluminium section on the hinge side.

The Avantage 1V ME is equipped with an RFT VAME re-setting motor comprising:

- DC electric motor,
- electric coupling,
- gear box,
- control lever,
- circuit board 0.

The motor is installed on the door using five steel M5 screws.

The operating lever is guided in a slot in the steel profile. The door is held in the open position by locking the lever in this slot.

6.3.1.6. Grille

The grille, reference "GFV PB", comprises a metal frame and mesh.

The frame comprises four 53.5 x 15 steel sections 2 mm thick, welded together. The mesh, of perforated aluminium sheet with a 10 x 10 mm mesh, is welded to the frame and has 69.4 % free surface.

The damper grille can be modified as long as the material of the mesh remains identical, and it presents a free physical surface area equal to or greater than that tested. Fixing of the grille to the damper must remain unchanged. This grille may also be removed from the damper and assembled to the decorative wall when the damper is entirely covered by the grille.

6.3.1.7. Option

The damper is also available in the AVANTAGE VAMEUK version (trade name: AVANTAGE DP) single door. It is a damper equipped with a DD90/24VDC (AUMULLER) servomotor which allows the damper to be opened and closed.

The motor is attached to the door by means of a stainless steel bracket of dimensions 165 x 45 x 57 x 3 mm and three steel M5 screws.

The operating lever is guided in a slot in the steel profile. The door is held in the open position by locking the lever in this slot.

There is neither a spring in the hinges, nor terminal box.

6.3.2. AVANTAGE 2V and AVANTAGE H 2V P smoke control dampers

6.3.2.1. Doors

The doors comprise an assembly formed of a panel and support sections (two vertical, one horizontal) in 1.25 mm thick galvanised steel:

- one panel on the side facing the fire, in refractory of type Promatect H 15 mm thick or IGNIBOARD (manufacturer Keen Eagle) 15 mm thick, and of bulk density 900 kg/m³.

The three sections are positioned on the rear of this panel:

- the vertical support profiles are U-shaped, with dimensions 47.5 x 29.3 mm,
- the horizontal profile is C-shaped, with dimensions 69.5 x 47.5 mm.

These three profiles are fixed to the Promatect H panel with four steel rivets Ø 4.8 mm.

6.3.2.2. Damper tunnel

The tunnel is formed of a framework in extruded aluminium profiles 60 x 54 mm, assembled using Zamak connectors.

Inside, each profile is fitted along its length with a refractory panel in Promatect H of section 10 x 81 mm (th x l) fixed with steel rivets Ø 4.8 mm at 420 mm intervals.

6.3.2.3. Sealing

Cold sealing is provided by:

- a profiled rubber seal 7.3 x 23 mm for all dampers or profiled rubber seal VA-D217-B 17.6 x 7.3 mm (w x th) (except AVANTAGE DP) crimped into the extruded tunnel profile.
- Or
- a profiled silicone seal 14.7 x 14.4 mm reference VAME-D217 crimped into the extruded tunnel profile.

Hot sealing is provided by an RFT EX-539P type intumescent seal or "Rectorseal Blaseseal" type seal (manufactured by Rectorseal) 15 x 2 mm, retained in the Promatect door panel using steel staples 8 x 12 mm (w x h) at 30 mm intervals.

6.3.2.4. Holding in open position

The doors are retained in an open position by an arm in 2 mm thick folded sheet steel rotating around a shaft fixed to the vertical aluminium profile on the hinge side. The arm is guided in a plastic part fixed in the horizontal support section. In the open position a torsion spring fitted in the arm pushes the arm into an opening in the support profile.

6.3.2.5. Hinging

Each door hinges on two 1.25 mm thick sheet steel hinges, having a Ø 5 mm rotating shaft, that are fixed to the door by two M5 steel bolts and nuts, and to the tunnel with three steel rivets Ø 4.8 mm. The two hinges are fitted with compression springs allowing the door to open.

6.3.2.6. Mechanism

The doors are held in the closed position by an Rf-T "VAL" type lock, consisting of three parts in Zamak, three springs, two parts in galvanised steel, a lock and a counter-panel.

The lock is fitted into one of the two doors in the horizontal support profile using Ø 5 mm steel screws. The door without lock is retained in a closed position by the door with the lock, by means of an extension to the support section.

Manual operation is by means of a steel key.

Electrical operation is achieved by demagnetisation of the lock.

The position of the door is detected with two position sensors, of Crouzet V4 or Keen Eagle type, installed in a plastic part held in the horizontal support profile.

The position sensors and lock are connected with an "Atem euro connector block" terminal block, fitted in a connecting unit that is snapped into the aluminium section on the hinge side.

6.3.2.7. Grille

A grille is attached to the dampers by four steel screws.

The grille, reference "GFV PB", comprises a metal frame and mesh.

The frame consists of four 53.5 x 15 mm steel sections 2 mm thick, welded together. The grille, of perforated aluminium sheet with a 10 x 10 mm mesh, is welded to the frame and has 69.4% free surface.

The damper grille can be modified as long as the material of the mesh remains identical, and it presents a free physical surface area equal to or greater than that tested. Fixing of the grille to the damper must remain unchanged. This grille may also be removed from the damper and assembled to the decorative wall when the damper is entirely covered by the grille.

In the case of finned grilles, the free surface area is calculated from the ratio between the smallest opening between two blades and the blade interval.

6.3.3. Options

- Installation of dampers using an EASY-KAP sub-frame:

An EASY-KAP sub-frame may be installed on the duct to hold the damper.

Fixing of the sub-frame to the duct is provided by four screws Ø 6 x th duct mm.

Fixing of the damper to the sub-frame is by four steel bolts M3.5 x 32 mm.

- Application of mastic in the angle formed by the damper frame and surface of the duct:

The space between the frame section and the surface of the duct may be filled with acrylic mastic to provide a uniform finish at the joint between frame and wall.

- For painting the damper doors:

The Avantage type damper doors may be coated with a layer of paint on the unexposed side.

- Painting of the damper frame:

The frame to receive the Avantage type dampers may be coated with a layer of paint on the unexposed side.

- Painting on the metal framework of the door:

The metal framework on the doors of Avantage type dampers may be coated with a layer of paint on the unexposed side.

7. INSTALLATION OF ELEMENTS TESTED

7.1. FOR A DUCT IN PROMATECT, GEOFLAM, GEOFLAM LIGHT, TECNIVER, EXTHAMAT P, GLASROC, DESENFIRE OR GEOTEC® S

For the installation of each damper an opening is made on one face of the duct:

- for installation with sub-frame (EASY-KAP type):
 - o a cut-out of dimensions $(W + 2 \times \text{duct thickness} + 20) \times (H + 2 \times \text{duct thickness} + 20)$ mm
- for installation without sub-frame:
 - o of dimensions $(W + 2 \times \text{duct thickness} + 10) \times (H + 2 \times \text{duct thickness} + 10)$ mm.

The cut-out for the damper is then strengthened with a sleeve of plasterboard panels of the same type as those used for the duct, having a total depth of 105 mm.

The dampers are fixed to the duct by sleeves. This sleeve may be affixed independently:

- Within the duct,
- In the axis of the duct,
- On the outside of the duct,
- Offset from the duct (in an off-duct).

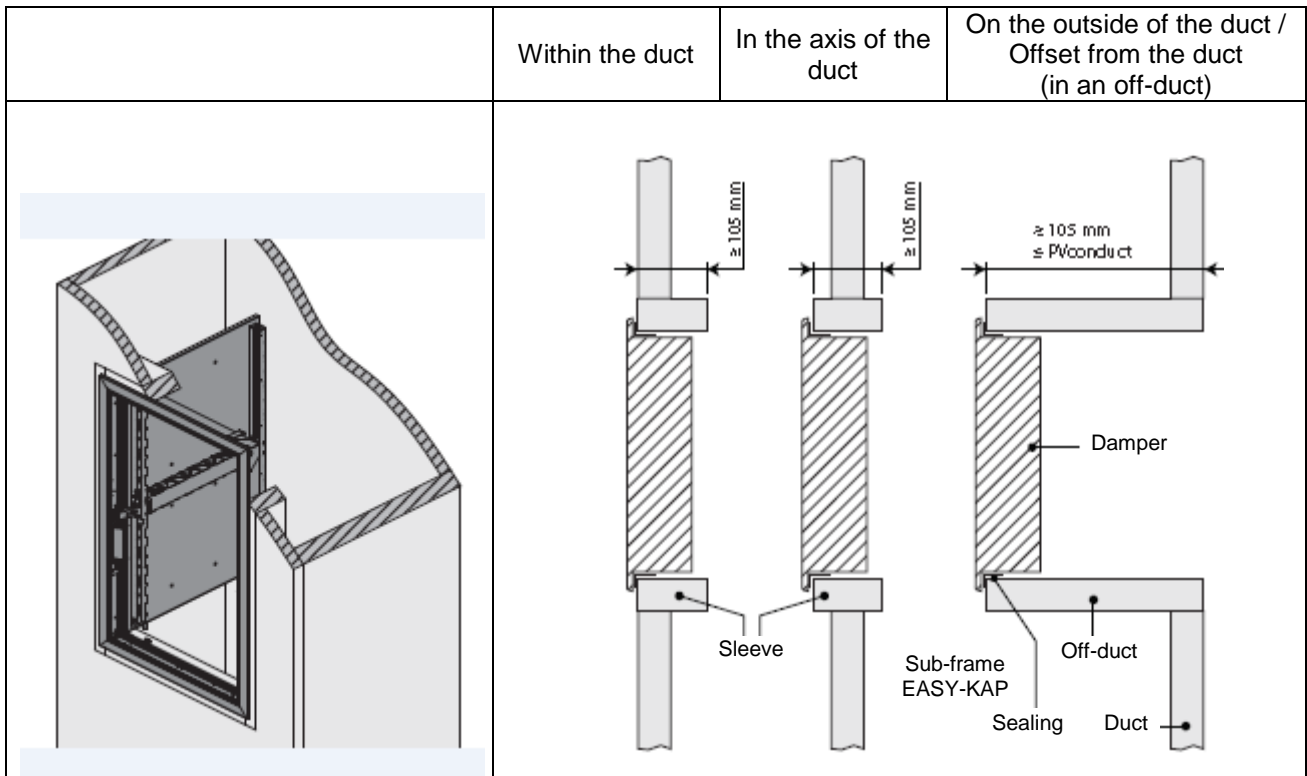

Finally, for installation of each damper:

- for installation with EASY-KAP sub-frame:
 - o the damper is installed into the sub-frame and mounted onto the latter with four steel bolts, M3.5 x 32 mm.
- for installation without sub-frame:
 - o the damper is installed into the duct and fixed onto the latter with four steel screws Ø 6 x 40 mm.

7.1.1. Installation on a PROMATECT L500 type duct

The sleeve comprises two cross-pieces and two uprights, also made of PROMATECT L500 of the same thickness as that of the duct itself (30, 40 or 50 mm), fixed together and to the wall.

Where installation is with a sub-frame the openings are first coated with Promacol S, then the sub-frame is fixed to the sleeve with VBA 6 x 30 or 40 or 50 mm screws and finished with PROMACOL S, thus reducing the free dimension of the opening to $(W + 10) \times (H + 10)$ mm.

7.1.2. Installation on a GEOFLAM or GEOFLAM LIGHT type duct

The sleeve comprises two cross-pieces and two uprights, also made of GEOFLAM of the same thickness as that used for the duct itself (30, 35 or 45 mm) or GEOFLAM LIGHT of the same thickness as that used for the duct (35 mm).

The edges of the opening were coated with PLACOL-type (BPB) adhesive plaster before embodying the crosspieces and uprights of the sleeve into the opening.

Sealing of the joints between uprights and cross-pieces and between the sleeve and the wall was achieved with vegetable fibre caulking + MOLDA plaster (DUO or NORMAL) (BPB).

Where installation is with a subframe, the subframe is caulked to the duct with vegetable fibre + MOLDA plaster (DUO or NORMAL) (BPB), reducing the free opening to dimensions $(W + 10) \times (H + 10)$ mm.

7.1.3. Installation on a TECNIVER type duct

The sleeve comprises two cross-pieces and two uprights, also in TECNIVER of the same thickness as that used for the duct (35, 45 or 50 mm), glued and screwed together and to the wall using VBA Ø 5 x 70 mm screws at 150 mm intervals.

The sealing of the joints between uprights and cross-pieces and between the sleeve and the wall is achieved with CF GLUE®.

For installation with subframe, openings are first coated with CF GLUE®, then the sub-frame is glued to the sleeve, reducing the free opening to dimensions $(W + 10) \times (H + 10)$ mm.

7.1.4. For installation on an EXTHAMAT P duct

The sleeve comprises two cross-pieces and two uprights, also made of EXTHAMAT P of the same thickness as that used for the conduit (25, 30, 35 or 45 mm).

The edges of the opening are coated with adhesive plaster before embodying the crosspieces and uprights of the lining into the opening.

Sealing of the joints between uprights and cross-pieces and between the sleeve and the wall is achieved using vegetable fibre caulking + plaster.

Where installation is with a sub-frame, the subframe is caulked to the duct, reducing the free opening to dimensions $(W + 10) \times (H + 10)$ mm.

7.1.5. For installation on a GLASROC F V500 duct

The sleeve comprises four cross-pieces also made of GLASROC F V500 of the same thickness as that used for the duct (35 or 50 mm), glued and screwed together and to the wall with VBA Ø 5 x 70 mm screws, at 150 mm intervals.

Sealing of the joints between uprights and cross-pieces and between the sleeve and the wall is achieved using GLASROC® F V500 adhesive

Following this, each opening receives an EASY-KAP sub-frame. Before these are installed, openings are first coated with Glasroc F V500, then the sub-frame is glued to the sleeve, reducing the free opening to dimensions $(W + 10) \times (H + 10)$ mm.

7.1.6. Installation on a DESENFIRE HD/THD/STR duct

The sleeve comprises two cross-pieces and two uprights, also made of DESENFIRE of the same thickness as that used for the duct itself (25HD, 25THD, 25STR or 35HD mm).

The edges of the opening are coated with FACILIS (SEMIN)-type adhesive plaster before embodying the cross-pieces and uprights of the sleeve into the opening.

Sealing of the joints between uprights and cross-pieces and between the sleeve and the wall is achieved using vegetable fibre caulking + LAFARGE plaster.

Where installation is with a subframe, the subframe is caulked to the duct with vegetable fibre + LAFARGE plaster, reducing the free opening to dimensions $(W + 10) \times (H + 10)$ mm.

7.1.7. For assembly on a GEOTEC® S duct

The sleeve comprises two cross-pieces and two uprights, also in GEOTEC® S of the same thickness as that used for the duct (30 or 45 mm), glued and caulked together and to the wall or glued and screwed together and onto the wall using VBA Ø 5 x as applicable 80 / 90 mm screws at 100 mm intervals.

The edges of the opening are coated with adhesive plaster of type GEOCOL or GEOCOL S (GEOSTAFF) before embodying the crosspieces and uprights of the sleeve into the opening.

Sealing of the joints between uprights and cross-pieces and between the sleeve and the wall is achieved with caulking or plaster tile glue GEOCOL or GEOCOL S (GEOSTAFF).

Where mounted with a sub-frame, the sub-frame is fastened to the duct by caulking or by plaster tile glue GEOCOL or GEOCOL S (GEOSTAFF) and by Ø 5 x as applicable 30 / 45 mm screws, so reducing the free opening to dimensions $(W + 10) \times (H + 10)$ mm.

7.2. FOR ASSEMBLY ON A PREFABRICATED CONCRETE DUCT TH = 70 MM

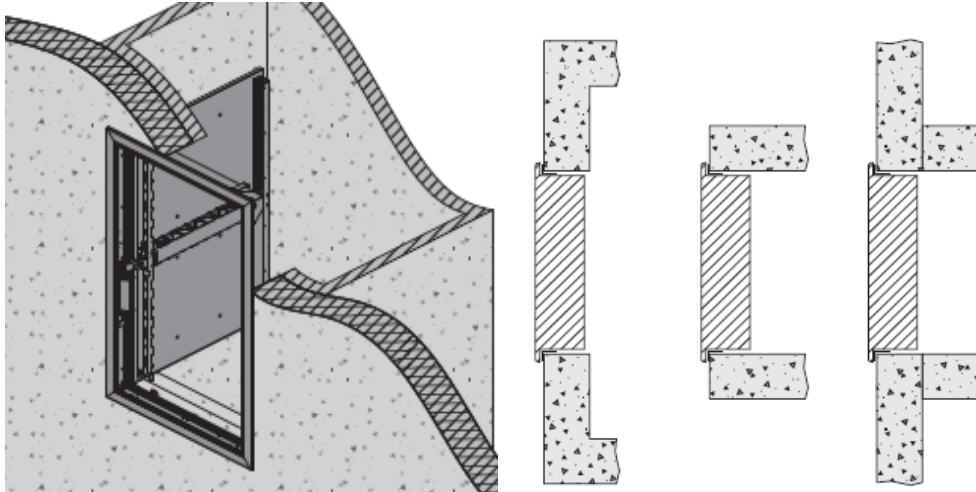

The dampers are fixed into the duct:

- Without sub-frame:

An opening of maximum dimensions $(W_n+10) \times (H_n+10)$ mm is made in the concrete duct of minimum thickness of 70 mm. The damper is installed in the opening and attached by four steel screws $\varnothing 6 \times 40$ mm.

- By sealing of the sub-frame:

An opening of maximum dimensions $(W_n+100) \times (H_n+100)$ mm is made in the concrete duct minimum thickness of 70 mm.

A sub-frame is sealed into the opening using mortar, so reducing the free opening to dimensions $(W_n+10) \times (H_n+10)$ mm. Two anchoring tabs are provided on each sub-frame upright and must be unfolded during the sealing.

Lastly, the damper is installed in the sub-frame and secured by four M3.5 x 32 bolts.

- By screwing the sub-frame:

An opening of maximum dimensions $(W_n+20) \times (H_n+20)$ mm is made in the concrete duct minimum thickness of 70 mm.

A sub-frame is fastened into this opening by screws using the tabs provided in the sub-frame by means of 4 screws $\varnothing 6$ mm.

Lastly, the damper is installed in the sub-frame and secured by four M6 bolts.

The maximum internal cross-section of the concrete ducts (validated) is 800 x 500 mm.

7.3. FITTING OF A PASSAGE'S DECORATIVE PLASTER PANEL IN FRONT OF THE SLEEVE OR DUCT CONTAINING THE DAMPERS

The decorative plaster panel (trim) for the passage can be fitted in front of the sleeve or duct containing the dampers:

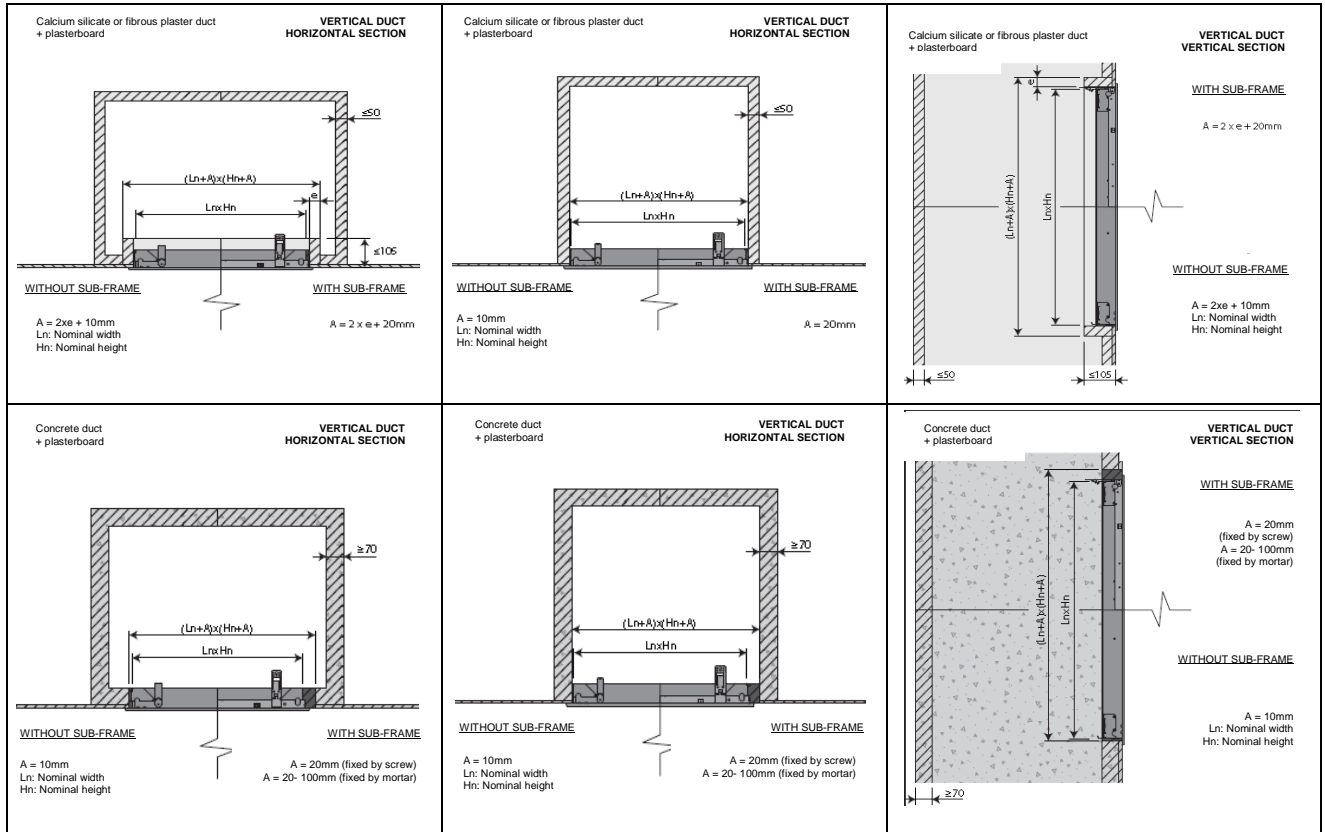

7.4. IMPLEMENTATION OF A WALL IN FRONT OF THE SLEEVE OR DUCT CONTAINING THE DAMPERS

A wall can be implemented in front of the sleeve or duct containing the dampers.

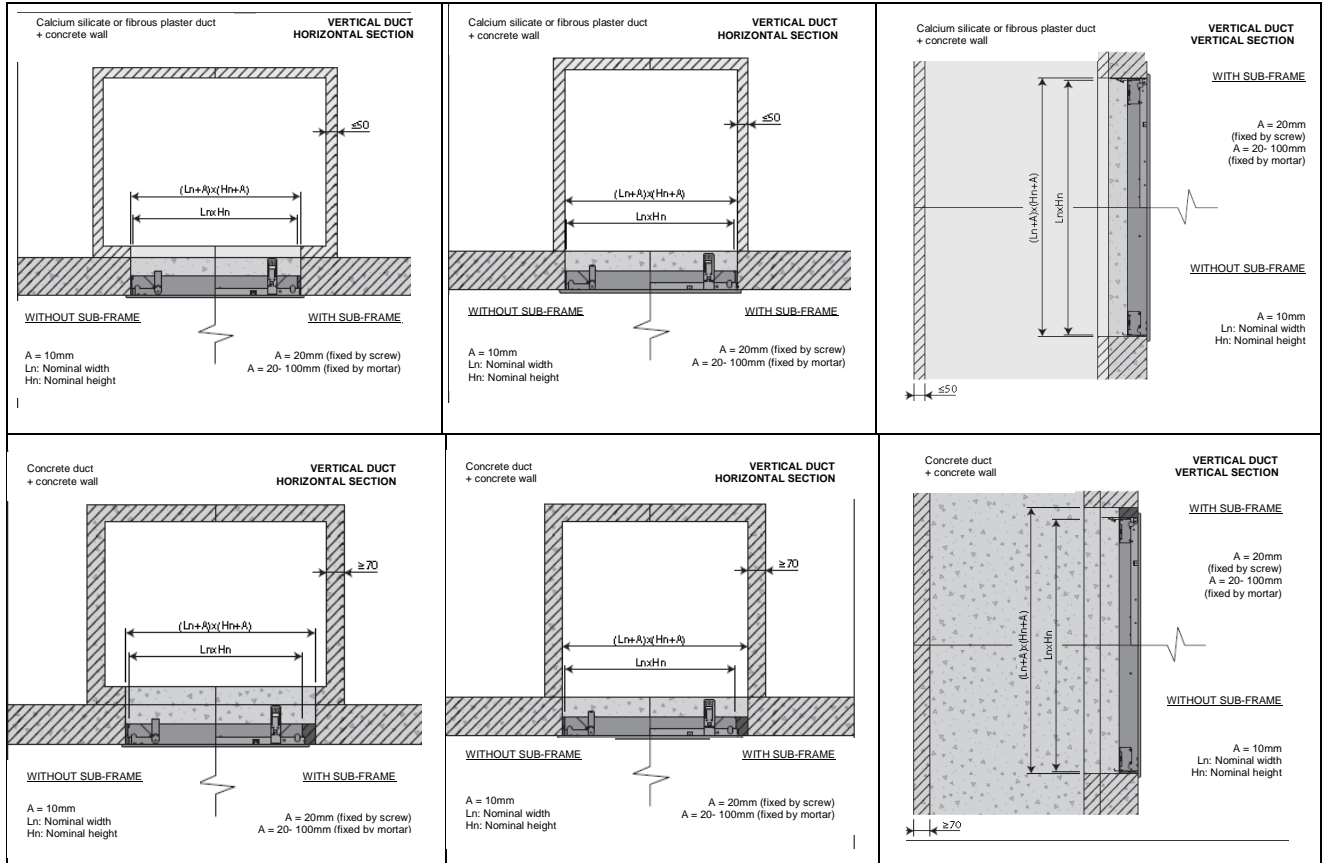

7.5. INSTALLATION OF DAMPERS IN A DUCT HAVING SIZES ADAPTED TO THE DIMENSIONS OF THE DAMPER

The dampers can be installed in ducts having sizes adapted to the dimensions of the damper, on condition that the ducts are validated in the Efectis France reference classification report 14-A-177 (while observing the maximum cross-section of the pre-fabricated concrete ducts).

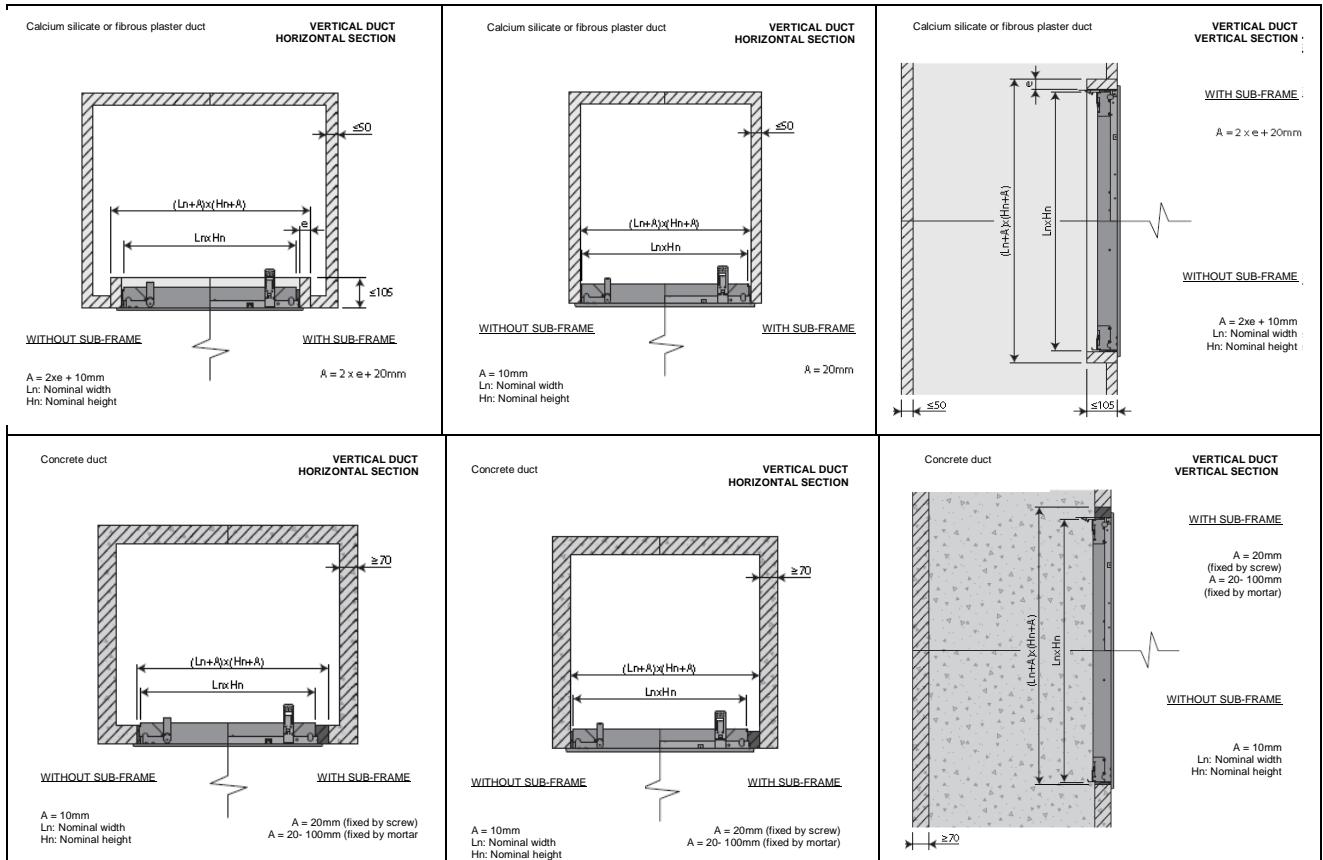

8. FIRE RESISTANCE CLASSIFICATIONS

8.1. CLASSIFICATION REFERENCES

This classification procedure was performed in accordance with Section 7.3.5. of Standard EN 13501-4.

8.2. CLASSIFICATION OF THE DAMPER RANGE AVANTAGE 1V (ME) / 2V OR AVANTAGE H 1V / H 2V 60

The elements are classified according to the following combinations of performance and class parameters.

Dampers type AVANTAGE 1V (ME) / 2V and AVANTAGE H 1V / 2V with this classification have undergone 300 cycles unloaded.

Dampers type AVANTAGE DP with this classification have undergone 10,200 cycles unloaded.

No other classification is permitted.

For dampers type AVANTAGE 1V (ME) / 2V or AVANTAGE H 1V / H 2V 60 fitted with grille installed:

Note: damper sizes must be adapted to the sizes of the prefabricated concrete duct (because the maximum internal section of the duct is less than the maximum section of the dampers).

- in a PROMATECT L500 duct th = 30 mm
- in a GEOFLAM duct th = 30 mm
- in an EXTHAMAT duct th = 25 mm
- in a DESENFIRE HD duct th = 25 mm
- in a GLASROC F/V500 duct th = 35 mm
- in a TECNIVER L35 duct th = 35 mm
- in an GEOTEC® S duct e = 30 mm
- in a prefabricated concrete duct th = 70 mm

E	I	-	t	S	Ved	ho	i	<->	o	Operating pressure	multi	AA
E	I		60	S	Ved	-	i	<->	o	-1500/+0 Pa	multi	AA

For dampers type AVANTAGE DP 60 fitted with grille installed:

Note: damper sizes must be adapted to the sizes of the prefabricated concrete duct (because the maximum internal section of the duct is less than the maximum section of the dampers).

	I	-	t	S	Ved	ho	i	<->	o	Operating pressure	multi	AA
E	I		60	S	Ved	-	i	<->	o	-500/+0 Pa	multi	AA

8.3. CLASSIFICATION OF THE DAMPER RANGE AVANTAGE 1V (ME) / 2V OR AVANTAGE H 1V / H 2V 120

The elements are classified according to the following combinations of performance and class parameters.

Dampers type AVANTAGE 1V (ME) / 2V and AVANTAGE H 1V / 2V with this classification have undergone 300 cycles unloaded.

Dampers type AVANTAGE DP with this classification have undergone 10,200 cycles unloaded.

No other classification is permitted.

For dampers type AVANTAGE 1V (ME) / 2V or AVANTAGE H 1V / H 2V 120 fitted with grille installed:

Note: damper sizes must be adapted to the sizes of the prefabricated concrete duct (because the maximum internal section of the duct is less than the maximum section of the dampers).

- in a PROMATECT L500 duct th = 40 mm
- in a GEOFLAM duct th = 35 mm
- in an EXTHAMAT duct th = 30 mm
- in a DESENFIRE THD duct th = 25 mm
- in a TECNIVER L35 duct th = 45 mm
- in a prefabricated concrete duct th = 70 mm

E	I	-	t	S	Ved	ho	i	<->	o	Operating pressure	multi	AA
E	I		90	S	Ved	-	i	<->	o	-1500/+0 Pa	multi	AA

For dampers type AVANTAGE DP 60 fitted with grille installed:

Note: damper sizes must be adapted to the sizes of the prefabricated concrete duct (because the maximum internal section of the duct is less than the maximum section of the dampers).

	I	-	t	S	Ved	ho	i	<->	o	Operating pressure	multi	AA
E	I		90	S	Ved	-	i	<->	o	-500/+0 Pa	multi	AA

8.4. CLASSIFICATION OF THE DAMPER RANGE AVANTAGE 1V (ME) / 2V OR AVANTAGE H 1V / H 2V 120

The elements are classified according to the following combinations of performance and class parameters.

Dampers type AVANTAGE 1V (ME) / 2V and AVANTAGE H 1V / 2V with this classification have undergone 300 cycles unloaded.

Dampers type AVANTAGE DP with this classification have undergone 10,200 cycles unloaded.

No other classification is permitted.

For dampers type AVANTAGE 1V (ME) / 2V or AVANTAGE H 1V / H 2V 120 fitted with grille installed:

Note: damper sizes must be adapted to the sizes of the prefabricated concrete duct (because the maximum internal section of the duct is less than the maximum section of the dampers).

- in a PROMATECT L500 duct th = 50 mm
- in a GEOFLAM duct th = 45 mm
- in a GEOFLAM LIGHT duct th = 35 mm
- in a GEOTEC S duct th = 45 mm
- in an EXTHAMAT duct th = 35 mm
- in a DESENFIRE HD duct th = 35 mm
- in a DESENFIRE duct th = 45 mm
- in a DESENFIRE 25 STR duct th = 25 mm in a TECNIVER L50 duct th = 45 mm
- in a GLASROC F/V500 duct th = 50 mm

E	I	-	t	S	Ved	ho	i	<->	o	Operating pressure	multi	AA
E	I		120	S	Ved	-	i	<->	o	-1500/+0 Pa	multi	AA

For dampers type AVANTAGE DP fitted with grille installed:

Note: damper dimensions must be adapted to the prefabricated concrete duct dimensions (because the maximum internal section of the duct is less than the maximum section of the dampers).

	I	-	t	S	Ved	ho	i	<->	o	Operating pressure	multi	AA
E	I		120	S	Ved	-	i	<->	o	-500/+0 Pa	multi	AA

9. SCOPE OF APPLICATION OF THE RESULTS

9.1. GENERAL

The requirements relating to the scope of application of all fire-resistant dampers submitted for testing in accordance with EN 1366-10 apply, as well as the following elements.

9.2. DIMENSIONS OF SMOKE CONTROL DAMPERS

Dampers with the following flush-mounted dimensions may be used:

- 300 x 385 to 700 x 1075 mm (l x h) for dampers with one door (AVANTAGE 1V),
- 350 x 385 to 1100 x 1105 mm (l x h) for dampers with two doors (AVANTAGE 2V),
- 350 x 385 to 700 x 1075 mm (l x h) for dampers with one motorised door (AVANTAGE 1V ME and AVANTAGE DP).

These dampers may be installed into ducts of all dimensions authorised in the scope of application stated in EN 1366-8 and in reports quoted in the document.

Multi-compartment smoke extraction dampers may be used on ducts implemented (on-site) during masonry works, on ducts and walls in concrete or cellular concrete, on condition that the multi-compartment smoke extraction ducts have been submitted to test on a duct or in a wall of materials of the least bulk density and thickness (for example, a panel or sheet metal element) and on condition that the structure in concrete or cellular concrete has a thickness conforming with information relating to the support structure stated in EN 1363-1 and EN 1366-2 for the duration of the classification required. Appropriate fixing elements, resistant to fire and suitable for the materials, must be used.

9.3. APPLICATION OF SMOKE CONTROL DAMPERS AT DIFFERENT POSITIONS IN THE DUCTS

The results given in section 7.2 of this classification report apply only to dampers installed on the vertical face of a smoke extraction duct.

9.4. PRESSURE DIFFERENCES

In accordance with standard EN 1366-10 - section 9.3 the performance levels specified in section 7.2 of this classification report are valid for any smoke extraction duct operating at a service pressure between -1500 Pa and +0 Pa.

9.5. ELEVATED TEMPERATURES

The multi-compartment smoke control dampers submitted for test in accordance with the standardised fire test curve in EN 1363-1 are suitable for single-compartment applications for the same period of time.

9.6. CYCLING TESTS

In accordance with standard EN 1366-10 - section 9.5.3, the performances specified in section 7.2 of this classification report that are valid for a smoke control damper that operates only in an emergency, are not applicable to other installations.

9.7. ACTIVATION METHOD

Smoke control dampers submitted for testing for automatic activation (AA) systems are not suitable for use in manual activation (MA) systems.

9.8. APPLICATION TO DUCT CONSTRUCTIONS OTHER THAN THOSE SUBMITTED TO TEST

Multi-compartment smoke control dampers may be used in ducts that have been tested in compliance with EN 1366-9 and EN 1366-8 as appropriate, constructed from materials of the same bulk density as those tested or from the same material but of greater density or thickness, as long as the service pressure authorised in the classification document for the destination smoke extraction duct is compatible.

Such use may not be made if there has been any change in the surface protection materials. Any paint finish must be identical to that of the duct when it is tested or evaluated.

Maizières-lès-Metz, 16 January 2020

X 
Romain
STOUVENOT

Project leader
Signé par : Romain STOUVENOT

X 
Roman
CHIVA

Supervisor
Signé par : CHIVA

ILLUSTRATIONS APPENDIX

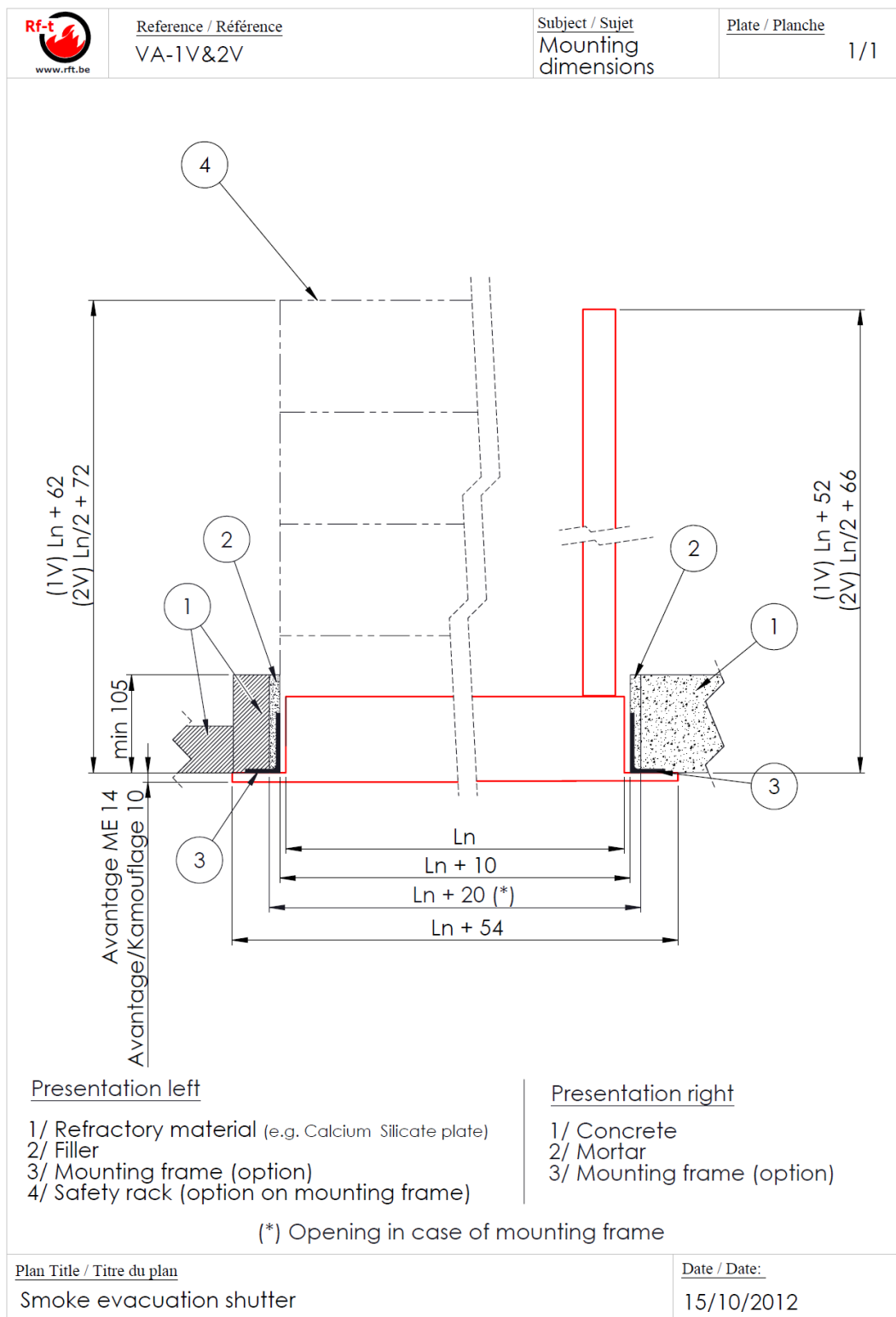

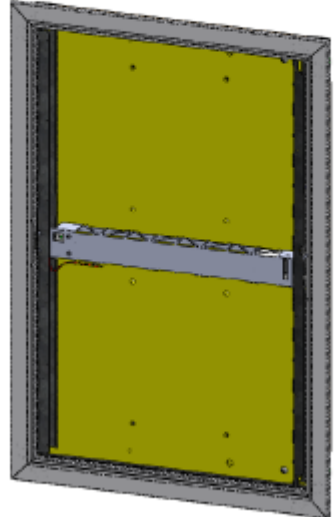
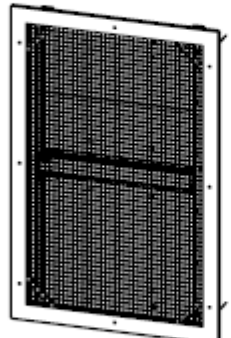
	<p>Reference / Référence VA-1V</p>
<p>BASIC (Avantage)</p>	
	
<p>BASIC VERSION + OPTION technical grill (Avantage + GFV-PB)</p>	
	
<p>Plan Title / Titre du plan Smoke Evacuation Shutter</p>	

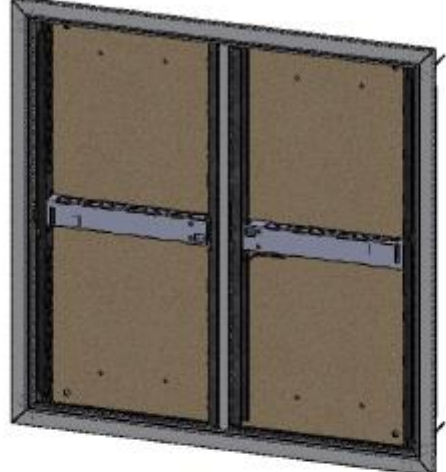
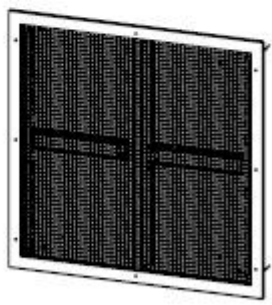
	<p>Reference / Référence VA-2V</p>
<p>BASIC (Avantage)</p>	
	
<p>BASIC VERSION + OPTION TECHNICAL GRILL (Avantage + GFV-PB)</p>	
	
<p>Plan Title / Titre du plan Smoke Evacuation Shutter</p>	

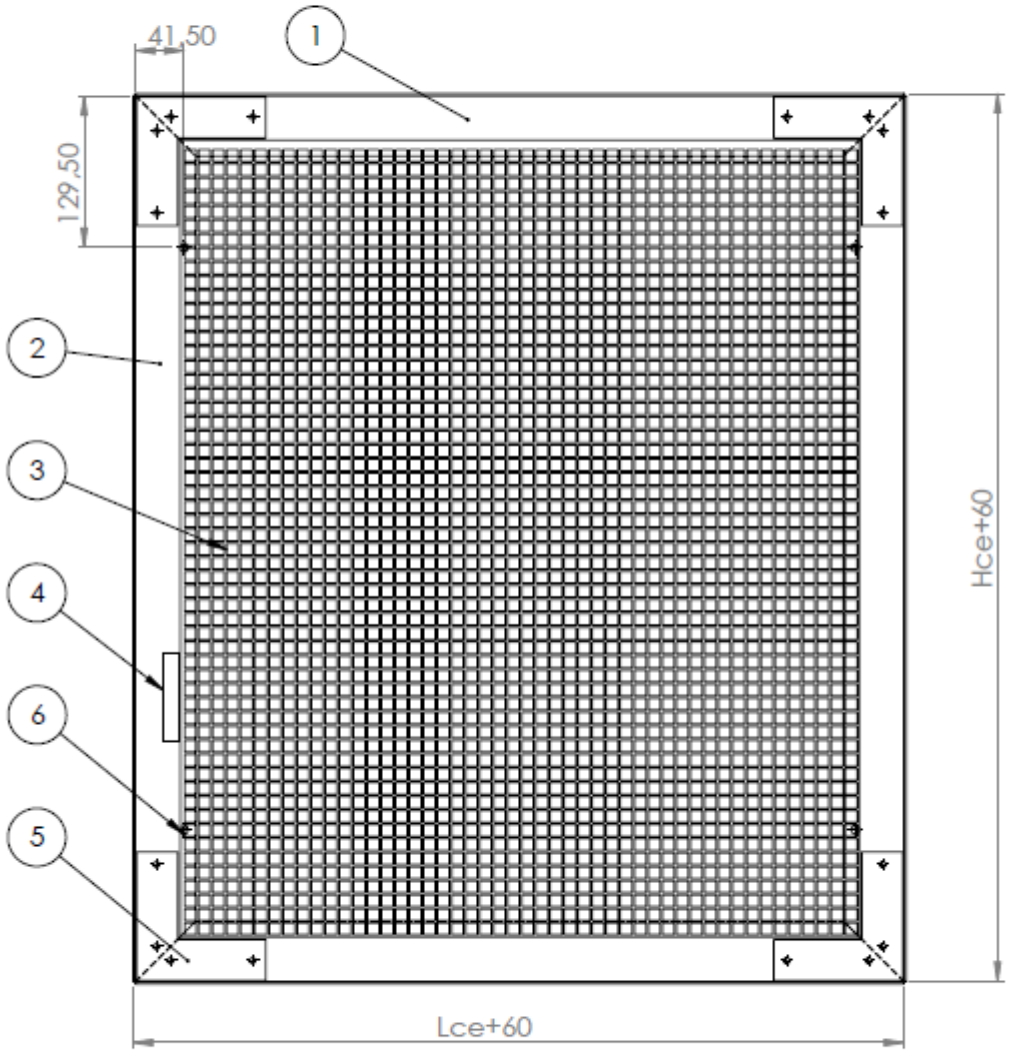
	<u>Reference / Référence</u> GFV-PB	<u>Subject / Sujet</u> Pièces/ Dimensions	<u>Plate / Planche</u> 1/1
<h2><u>Façade grill</u></h2> 			
<u>Plan Title / Titre du plan</u> Grille de façade		<u>Date / Date:</u> 18/12/2012	

	<p>Reference - Subject - Date 1V-2V Mounting frame - EASY-KAP 27-08-2019</p>	<p>Plate B 1/2</p>
---	--	---------------------------------

